

NETWORKTV

NTV61/NTV60/ NTV63SL

User Guide



SDI, HDMI & IP

Phone: Tel: +44 (0)333 335 5019

E-Mail: info@networktv.tv Web: www.networktv.tv

Release 1.0



TABLE OF CONTENTS

Preface	3
Notes	4
What's in the Box	4
Quick Start	5
Features	6
Product Specification	7
IR Remote Controller Explanation	9
RS-232 Interface	11
VISCA Network Configuration	12
Serial Communication Control	13
Command List	13
Menu Setting	14
Network Function	19
Maintenance and Troubleshooting	26



Preface

Thank you for choosing this SDI, HDMI and IP HD Video Conferencing Camera.

This manual introduces the function, installation and operation of the HD camera. Prior to installation and usage, please read the manual thoroughly.

Precautions

This product can only be used in the specified conditions in order to avoid any damage to the camera:

- Don't subject the camera to rain or moisture.
- Don't remove the cover. Otherwise, you may get an electric shock. In case of abnormal operation, contact the authorized engineer.
- Never operate under unspecified temperature, humidity and power supply.
- Please use a soft dry cloth to clean the camera. If the camera is very dirty, clean it with diluted neutral detergent; do not use any type of solvents, which may damages the surface.

Note

This is class A product. Electromagnetic radiation at the specific frequency may affect the image quality of TV in a home environment.

Copyright Notice

All contents of this manual are copyright and belong to our company. It cannot be cloned, copied or translated without the permission of the company. Product specifications and information which are referred to in this document are for reference only and the content may be updated at any time without prior notice.



Notes

- **Electrical Safety**

Installation and operation must be in accordance with the local electric safety standards.

- **Caution with handling**

Avoid stress, vibration and moisture in transport, storage, installation and operation.

- **Polarity of power supply**

The power supply of the product is +12V, the maximum electrical current is 2A. Polarity of the power supply plug is as per the drawing:



- **Care during installation**

Do not grasp the camera head when carrying the camera. Don't turn camera head by hand. Doing so may result in mechanical damage.

Don't apply corrosive liquid, gas or solid environment to avoid damaging the cover which is made of plastic material.

Make sure no obstacle is in the rotation range.

Never power off before installation is completed.

- **Don't dismantle the camera**

We are not responsible for any unauthorized modification or dismantling.

CAUTION!

The specific frequency of electromagnetic field may affect the image of the camera!

What's in the Box

When you unpack, check that all the supplied accessories are included:

Camera	1PCS
AC power adaptor	1PCS
Power cord	1PCS
RS232 cable	1PCS
Remote controller	1PCS



Quick Start

Step1: Please check connections are correct before starting

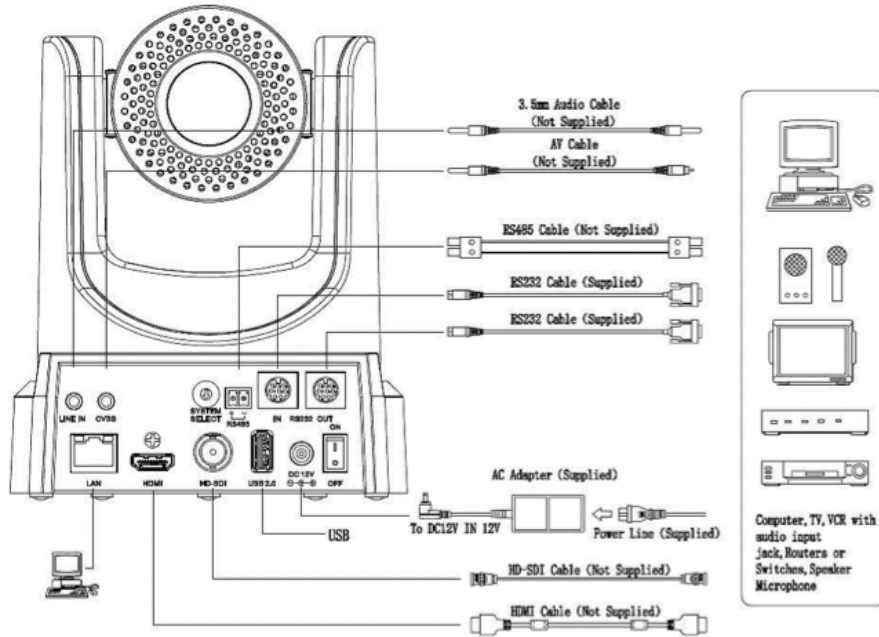

Step2: Power connected to the Camera, the front panel power lamp is lit.

Step3: Pan-Tilt will rotate to the maximum position of top right after the camera is started, then it will return to the centre, the process of initialisation is then complete. (Note: If the position preset 0 has been stored, the position preset 0 will be called up after initialisation).

Step 4: To set the video output, use the Dial on the back plate of the camera.

Video Format					
0	1080P/60	6	1080P/30	C	--
1	1080P/50	7	1080P/25	D	576I
2	1080I/60	8	720P/30	E	480I
3	1080I/50	9	720P/25	F	--
4	720P/60	A	--		
5	720P/50	B	--		



Notice

- After switching the video format, you need to restart the camera before taking effect!
- 720P/30 and 720P/25 only take effect when HDMI output.



Features

- **Completely New Look**
Designed with worm gear drive, completely new look, mini size.
- **1080P Full HD**
Panasonic's 1/2.7 inch, 2.07 million effective pixels high quality HD CMOS sensor, can reach maximum 1920 x 1080 resolution image quality.
- **Ultra-high Frame Rate**
The output frame rate up to 60fps in 1080P.
- **72.5° or 60.7° ~ 6.9° Wide-angle Lens + 32x Digital Zoom / 60.7° ~ 6.9°**
Wide-angle high quality lens, supports 12x optical zoom, and 32x digital zoom (optional)
- **AAC Audio Encoding**
Supports AAC audio encoding, better sound quality and smaller bandwidth.
- **HD Interface**
Supports Serial Digital Video (HD 3G-SDI) output.
Supports HDMI output.
- **Network Interface**
Supports network multi-channel audio and video stream output.
- **Low-light**
High SNR of CMOS sensor combined with 2D and 3D noise reduction algorithm, effectively reduces the noise, even under low illumination conditions, the picture will still stay clean and clear.
- **Remote Control**
Using RS232 and IP interface, all the parameters of the camera can be remote controlled.



Product Specification

Model	NTV61/NTV60/NTV63SL
Name	SDI/HDMI/IP HD PTZ Camera
Camera	
Sensor	1/3", CMOS, Effective Pixel: 2.12M
Scanning Mode	Progressive
Lens	12x, f3.5mm ~ 42.3mm, F1.8 ~ F2.8 / 20x, F3.5mm~42.3mm, F1.8~F2.8 / 30x, f4.42mm ~ 132.6mm, F1.8 ~ F2.8
Digital Zoom	16x (optional)
Minimal Illumination	0.5 Lux @ (F1.8, AGC ON)
Shutter	1/30s ~ 1/10000s
White Balance	Auto, Indoor, Outdoor, One Push, Manual
Backlight Compensation	Support
Digital Noise Reduction	2D&3D Digital Noise Reduction
Video S/N	≥55dB
Horizontal Angle of View	72.5° ~ 6.9° / 60.7° ~ 6.9° / 60.7° ~ 2.28°
Vertical Angle of View	44.8° ~ 3.9° / 34.1° ~ 1.89° / 34.1° ~ 1.28°
Horizontal Rotation Range	±170°
Vertical Rotation Range	-30° ~ +90°
Pan Speed Range	1.7° ~ 100°/s
Tilt Speed Range	0.7° ~ 28°/s
Horizontal & Vertical Flip	Support
Image Freeze	Support
PoE	Support
Face Detection	Support (optional)
Local Storage	Support
Number of Preset	255
Preset Accuracy	0.1°
IPC Features	
Video coding standard	H.265/H.264/MJPEG



Product Specification (cont.)

First Stream Resolution	1920x1080, 1280x720, 1024x576, 960x540, 640x480, 640x360
Second Stream Resolution	1280x720, 1024x576, 720x576, 720x408, 640x360, 480x270, 320x240, 320x180
Video Bit Rate	128Kbps ~ 8192Kbps
Bit Rate Type	Variable rate, Fixed rate
Frame Rate	1080p/60/30, 1080p/50/25, 720p/60/50, NTCS, PAL
Audio encode standard	AAC
Audio Bit Rate	96Kbps, 128Kbps, 256Kbps
Supported streaming protocols	TCP/IP, HTTP, RTSP, RTMP, Onvif, DHCP etc
Input/Output Interfaces	
HD Output	1x3G-SDI: BNC type, 800mVp-p, 75Ω, complies with the SMPTE 424M standard, CVBS 1xHDMI 1.3
Network interface	1xRJ45: 10/100/1000M Adaptive Ethernet ports
Audio Interface	1-ch: 3.5mm Audio Interface, Line In
Communication Interface	RS232 In & Out (8 pin mini Din), RS485 (2 pin Phoenix) VISCA/Pelco-D & P
USB Interface	USB 2.0 *(for updates only)
Power Jack	JEITA type (DC IN 12V)
Generic Specification	
Input Voltage	DC 12V / PoE (802.3af)
Current Consumption	1.0A (Max)
Operating Temperature	-10°C ~ 40°C (14°F ~ 104°F)
Storage Temperature	-40°C ~ 60°C (-40°F ~ 140°F)
Power Consumption	12W (Max)
MTBF	>30000h
Size	169mm x 142mm x 164mm
Net Weight	1.35K g



IR Remote Controller Explanation

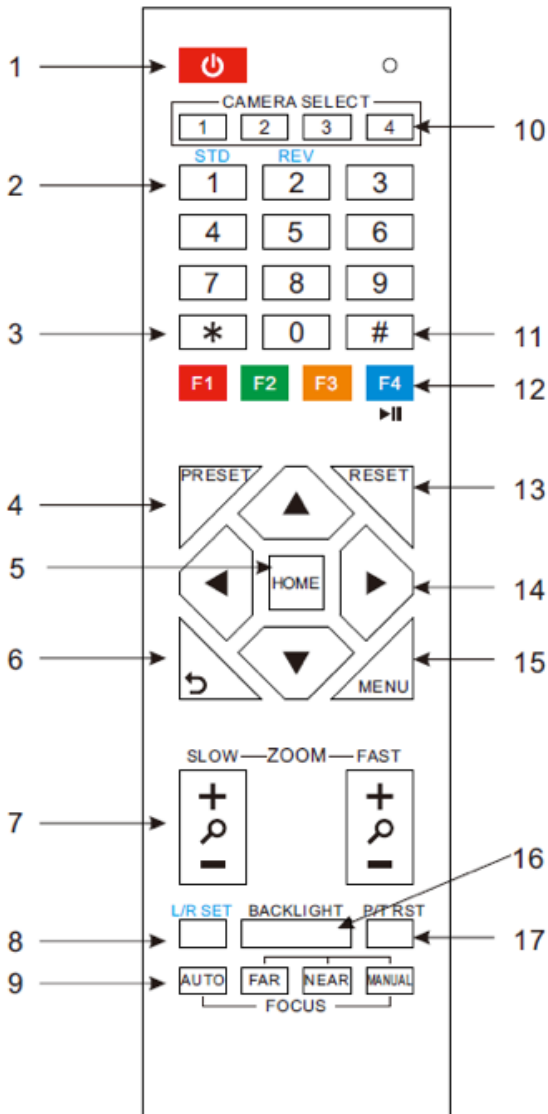

1. Standby Button

Press this button to enter standby mode. Press it again to enter normal mode. (Note: Power consumption in standby mode is approximately half of the normal mode)

2. Position Buttons

To set preset or call preset

3. *Button

Used with other buttons

4. Set/Preset Buttons

Set preset: Store a preset position

[SET PRESET] + Numeric button (0-9): Setting a corresponding numeric key preset position

5. Pan-Tilt control Buttons

Pressing the Pan-Tilt back to the middle position

6. MENU

MENU: enter or exit OSD MENU

7. Zoom Buttons

Slow Zoom: Zoom In [+] or Zoom Out [-] slowly

Fast Zoom: Zoom In [+] or Zoom Out [-] fast

8. Pan-Tilt L/R set

Press with 1 buttons and 2 buttons setting the direction of the Pan-Tilt

L/R Set +1[STD]: set the Pan-Tilt turn the same direction as the L/R Set

L/R Set +2[REV]: set the Pan-Tilt turn the opposite direction as the L/R Set

9. Focus Buttons

Used for focus adjustment.

Press [AUTO] adjust the focuses on the center of the object automatically. To adjust the focus manually. Press [MANUAL] adjust the focus on the center of the object manual

MANUAL button, and adjust it with [Far] (Focus on far object) and [NEAR] (Focus on near object)



IR Remote Controller Explanation (cont.)

10. Camera Select Buttons

Press the button corresponding to the camera you want to operate with the remote controller.

11. # Button

Used with other buttons

12. Set Camera IR Address Buttons

[*]+[#]+[F1]: Address1

[*]+[#]+[F2]: Address2

[*]+[#]+[F3]: Address3

[*]+[#]+[F4]: Address4

13. Clear Preset Buttons

Clear preset: Erase a preset position

[CLEAR PRESET] + Numeric button (0-9)

Or: [*]+[#]+[CLEAR PRESET]: Erase all the preset individually

14. Pan/Tilt Control Buttons

Press arrow buttons to perform panning and tilting. Press [HOME] button to face the camera back to front

15. Back buttons

Press the OSD menu return to the superior.

[*]+[#]+[9]: Quickly set up inversion

16. BLC (Backlight Compensation) Button

BLC ON/OFF: Press this button to enable the backlight compensation. Press it again to disable the backlight compensation.(NOTE: Effective only in auto exposure mode)

Note: If there is light behind the subject, the subject will become dark. In this case, press the backlight ON / OFF button. To cancel this function, press the backlight ON / OFF button.

17. Pan/Tilt reset

Preset Pan/Tilt self-test.

18. Image freezing function

Manually freeze: Open the freezing function after press the remote control [F4], display "Freeze" on the left upper corner character, after 5 seconds display disappear automatically. If you want to cancel the freeze, press [F4] key and then can return to normal, display "Unfreeze" on the left upper corner, after 5 seconds the display will disappear automatically.

Recalling the Preset image Freeze: By the OSD Menu Setting "Recalling the Preset image Freeze" function. After the function is opened, the screen will stay in before Recalling the Preset when Recalling the Preset, the screen can be switched to the preset position screen until the camera points to the preset position.

19. Shortcut Set

[*]+[#]+[1]: OSD menu default English

[*]+[#]+[3]: OSD menu default Chinese

[*]+[#]+[4]: Default IP address

[*]+[#]+[5]: Save OSD

[*]+[#]+[6]: Quickly recover the default

[*]+[#]+[8]: Look the camera version

[*]+[#]+[9]: Quickly set up inversion

RS-232 Interface

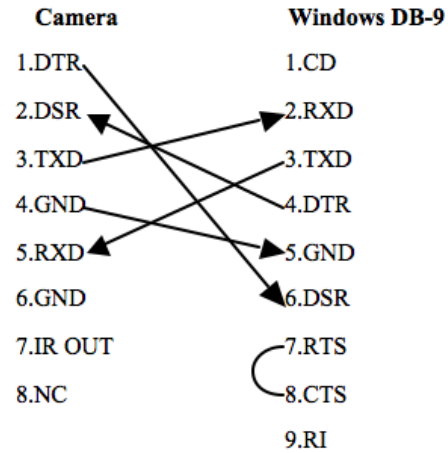
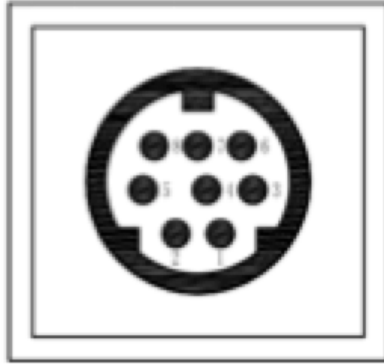

No.	Function
1	DTR
2	DSR
3	TXD
4	GND
5	RXD
6	GND
7	IR OUT
8	NC

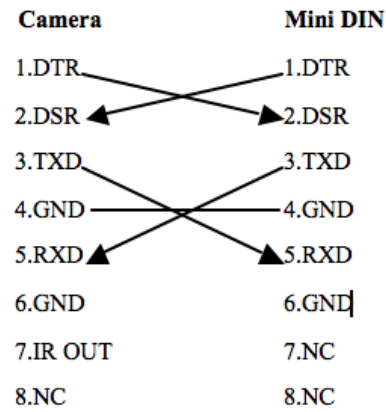

VISCA Network Configuration

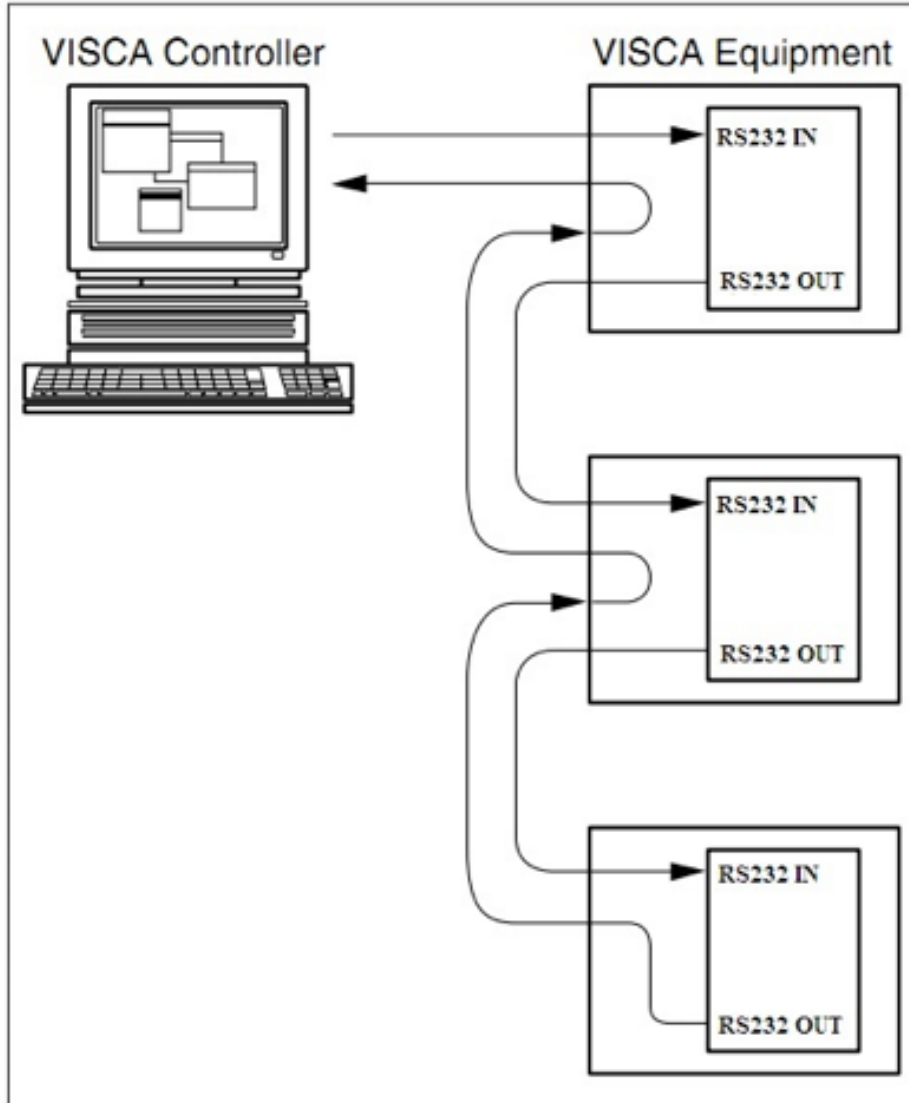



Serial Communication Control

In default working mode, the camera is able to connect to a VISCA controller with RS232C serial interface.

- **RS232 Communication Control:**
The camera can be controlled via RS232, the parameters of RS232C are as follows:
Baud rate: 2400/4800/9600 bit/s.
Start bit: 1 bit.
Data bit: 8 bits.
Stop bit: 1bit.
Parity bit: none.

- **RS485 Communication Control:**
The camera can be controlled via RS485, half-duplex mode:
Baud rate: 2400/4800/9600 bit/s.
Start bit: 1 bit.
Data bit: 8 bits.
Stop bit: 1bit.
Parity bit: none.

When powered on, Pan-Tilt will rotate to the maximum position of top right after the camera started, then it returns to the centre, the process of initialization is finished. (Note: If the position preset 0 has been stored, the position preset 0 will be called up after initialization). Then the users can control the camera with commands in the command list.

PTZ over TCP/UDP Realize

There is a TCP server built into the camera with a default port number of 5678. When the client has established a TCP connection with the server, the client can send PTZ control commands to the server, the server will then parse and execute the PTZ command.

There is also a UDP server built into the camera with a default port number of 1259. When the client has established a connection to the server and send PTZ control commands, the server will then parse and execute the PTZ command.

Command List

Note: The camera serial standard is VISCA/Pelco-D/Pelco-P. If you need VISCA/Pelco - D/Pelco - P protocol command list in detail, they are published on the networktv.tv website.



Menu Setting

I. MENU

Press [MENU] button to display the main menu on the normal screen, using the arrow button to move the cursor to the item to be set. Press the [HOME] button to enter the corresponding sub-menu.

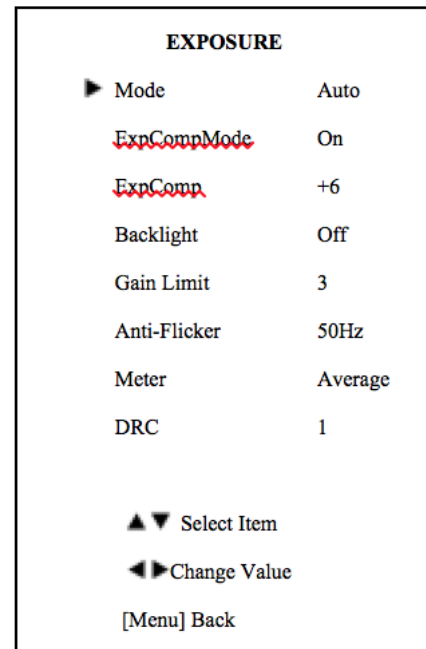
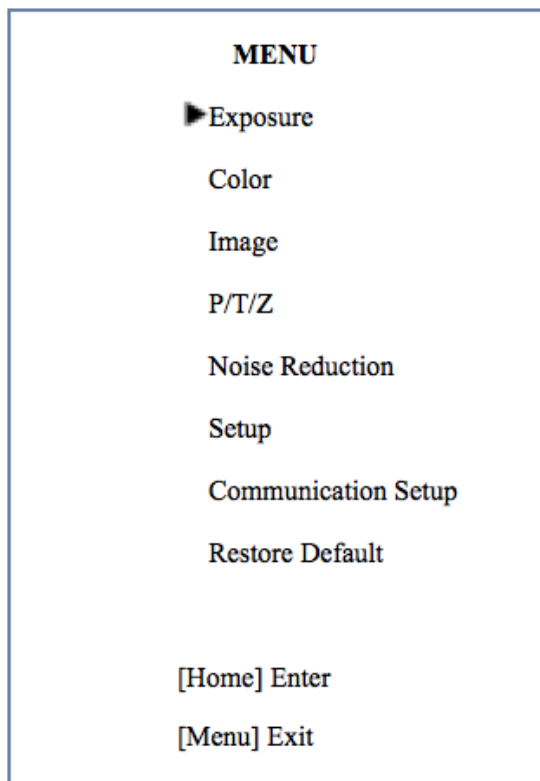

2. EXPOSURE

Move the cursor to the Exposure item in the main menu and press [home] button, EXPOSURE menu appears, as shown in the following figure.

Mode: Exposure mode. Optional items: Auto, Manual, SAE, AAE, Bright

ExpCompMode: Exposure compensation mode, Optional items: On, Off (Effective only in Automode)

ExpComp: Exposure compensation value, Optional items: -7 ~ 7 (Effective only in ExpCompMode item is set to On)

Gain Limit: Maximum gain limit. Optional items: 0 ~ 15 (Effective only in Auto, AAE, Bright mode)

Backlight: Set the backlight compensation, Optional items: On, Off (Effective only in Auto mode)

DRC: DRC strength, Optional items: 0 ~ 8.

Menu Setting (cont.)

Bright: Intensity control, Optional items:

00~17. (Effective only in Bright mode).

Anti-Flicker Flicker: Anti-flicker. Optional items: Off, 50Hz, 60Hz (Effective only in Auto, Bright mode).

Meter: Optional items: Average, Centre, Bottom, Top.

Iris: Aperture value. Optional items: F1.8, F2.0, F2.4, F2.8, F3.4, F4.0, F4.8, F5.6, F6.8, F8.0, F9.6, F11.0, Close (Effective only in Manual, AAE mode).

Shutter: Shutter value. Optional items: 1/30, 1/60, 1/90, 1/100, 1/125, 1/180, 1/250, 1/350, 1/500, 1/725, 1/1000, 1/1500, 1/2000, 1/3000, 1/4000, 1/6000, 1/10000 (Effective only in Manual, SAE mode).

3. COLOUR

Move the cursor to the Colour item in the main menu and press [home] button, COLOUR menu appears, as shown in the following figure.

COLOR	
▶ WB Mode	Auto
RG Tuning	+6
BG Tuning	+2
Saturation	110%
Hue	7
AWB sens	Low
▲▼ Select Item	
◀▶ Change Value	
[Menu] Back	

WB-Mode: White balance mode. Optional items: Auto, Indoor, Outdoor, Onepush, Manual

RG: Red gain. Optional items: 0~255 (Effective only in Manual mode).

BG: Blue gain. Optional items: 0~255 (Effective only in Manual mode).

RG Tuning: Red gain fine-tuning, Optional items: -10 ~ +10 (Effective only in AWBsens is Low).

BG Tuning: Blue gain fine-tuning, Optional items: -10 ~ +10 (Effective only in AWBsens is Low)

Sat.: Saturation. Optional items: 60% ~ 200%.

Hue: Chroma adjustment, Optional items: 0 ~ 14.

AWBsens: The white balance sensitivity
Optional items: Normal, High, Low.



Menu Setting (cont.)

4. IMAGE

Move the cursor to the Image item in the main menu and press [home] button, IMAGE menu appears, as shown in the following figure.

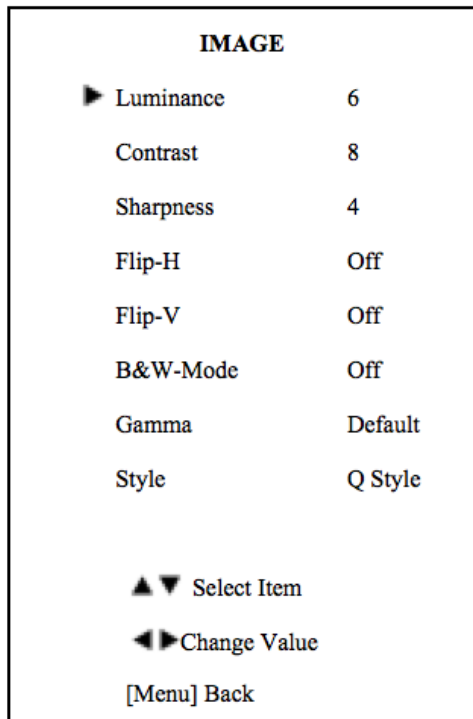

Luminance: Brightness adjustment. Optional items: 0 ~ 14

Contrast: Contrast adjustment. Optional items: 0 ~ 14

Sharpness: Sharpness adjustment. Optional items: Auto, 0 ~ 15

Flip-H: Image flipped horizontally. Optional items: On, Off.

Flip-V: Image Flip Vertical. Optional items: On, Off

B&W-Mode: Image color. Optional items: On, Off

Gamma: Optional items: Default, 0.45, 0.5, 0.56, 0.63

Style: Optional items: Norm, Clarity, Bright, Soft, 5Q, Q Style.

5. P/T/Z

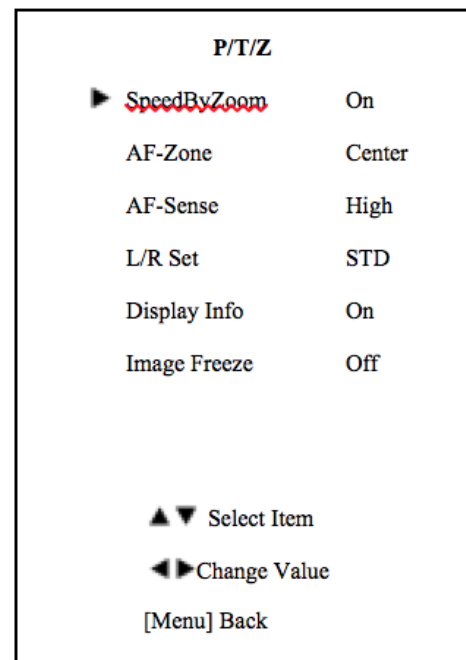

SpeedByZoom: The depth of field scale switch, Optional items: On, Off

AF-Zone: Interested in focusing area, Optional items: Top, Center, Bottom

AF-Sense: Automatic focusing sensitivity options, Optional items: Low, Normal, High

L/R Set: Optional items: STD, REV

Display Info Optional items: On, Off

Image Freeze: Optional items: On, Off



Menu Setting (cont.)

6. NOISE REDUCTION

Move the cursor to the NOISE REDUCTION item in the main menu and press [home] button, NOISE REDUCTION menu appears, as shown in the following figure.

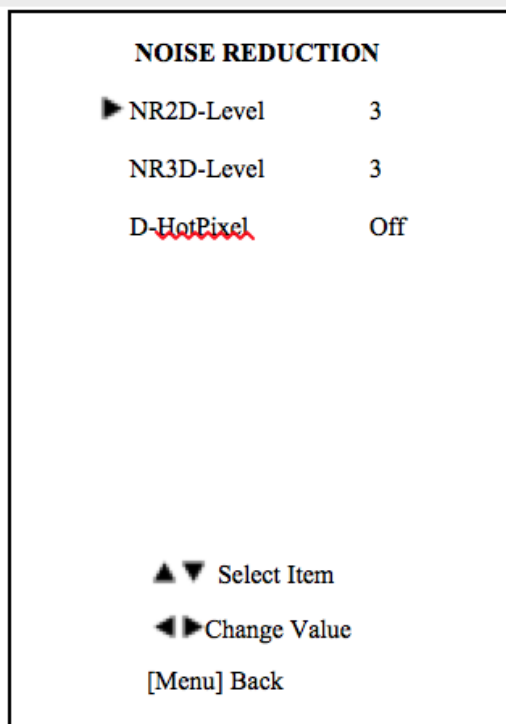

NR2D-Level: 2D noise reduction. Optional items: Off, Auto, 1 ~ 5

NR3D-Level: 3D noise reduction. Optional items: Off, 1 ~ 8

D-HotPixel: Dynamic bad points, Optional items: Off, 1 ~ 5

7. SETUP

Move the cursor to the Setup item in the main menu and press [home] button, SETUP menu appears, as shown in the following figure.

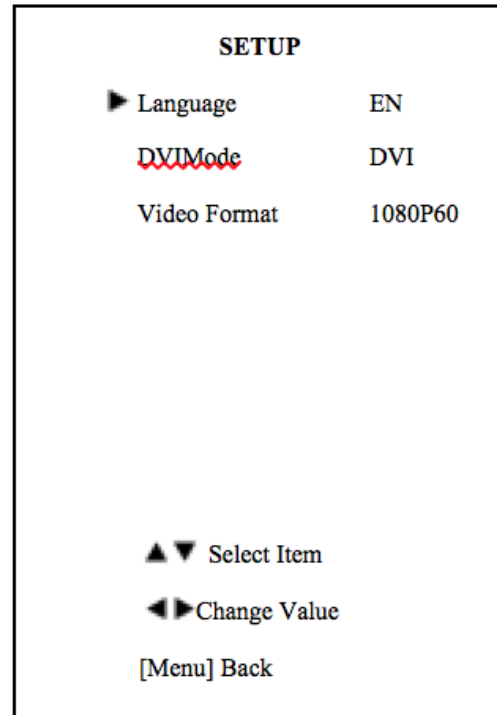

Language: menu language, Optional items: EN, Chinese, Russian

DVI Mode: Optional items: DVI, HDMI

Video Format: Optional items: 1080P60, 1080P50, 720P60, 720P50, 1080P30, 1080P25, 720P30, 720P25

8. COMMUNICATION SETUP

Move the cursor to the Setup item in the main menu and press [home] button, the COMMUNICATION SETUP menu appears, as shown in the following figure.



Menu Setting (cont.)

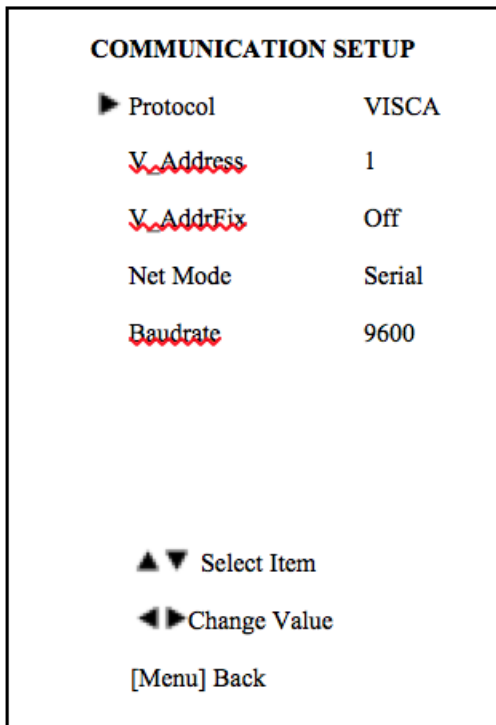

Protocol: Control protocol type. Optional items: AUTO, VISCA, PELCO-D, PELCO-P

V_Address: Protocol address, To be decided according to the agreement, AUTO, VISCA protocol Optional items: 1 ~ 7

P_D_Address: PELCO-D protocol Optional items: 0 ~ 254

P_P_Address: PELCO-P protocol Optional items: 0 ~ 31

V_AddrFix: If I can change through the serial port of infrared switch, Optional items: On, Off (When set to On, useless in 88 30 01 FF Command).

Net Mode: Set the serial port control networking, Optional items: Serial, Paral

Baudrate: Serial port baud rate. Optional items: 2400, 4800, 9600

9. RESTORE DEFAULT

Move the cursor to the Restore Default item in the main menu and press [home] button, RESTORE DEFAULT menu appears, as shown in the following figure:

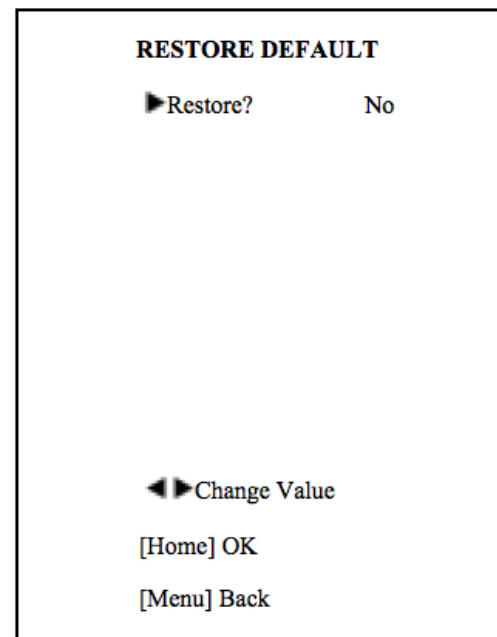

Restore: Confirm restore factory settings. Optional items: Yes, No

Note: Press [HOME] button to confirm, All parameter restore default, Include IR Remote address and VISICA Address

Save: Save Options. Optional items: Yes, No



Network Function

1. Operating Environment

Operating System: Windows 2000/2003/XP/vista/7/8/10

Network Protocol: TCP/IP

Client PC: P4/128MRAM/40GHD/ support scaled graphics card, support DirectX8.0 or more advanced version.

2. Equipment Installation

- 1) Connect the camera to your network or to your PC directly via network cable.
- 2) Turn on DC12V power.
- 3) The orange light of the network port will be lit with a green flashing light, the physical connection is ready.

3. Network Connection

Connect the camera to a computer in one of the 2 ways shown in pictures 1.1 and 1.2 below:

Picture 1.1 connect by network cable



Picture 1.2 Connect by router /switch

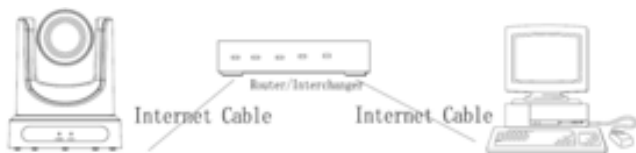

4. IP camera controlled over LAN

4.1 Set up IP address

The camera default IP address is: 192.168.100.88
If you don't know the camera's IP address, follow one of the instructions below:

Method 1: press * and # and 4 on remote controller one by one, the camera IP address will be shown on screen.

Method 2: connect camera to PC with an ethernet cable, and use the "upgrade_En.exe" programme to search for the IP address (programme available on the networktv.tv website).

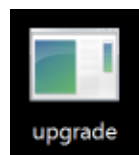

To change the IP address, follow the 2 methods below:

Method 1: On the web control page, click the "Network" tab and change the IP Address. Then click "Apply" to save and restart the camera.

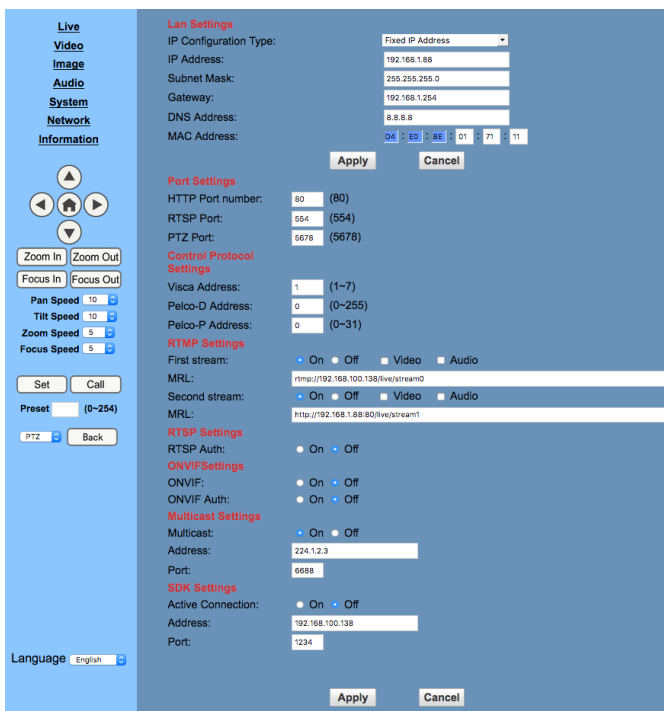



Method 2: Open "upgrade_En.exe", Click "Search" and it should find your camera/cameras. In Config, change its IP and click "Set". After you've modified the address, restart the camera.

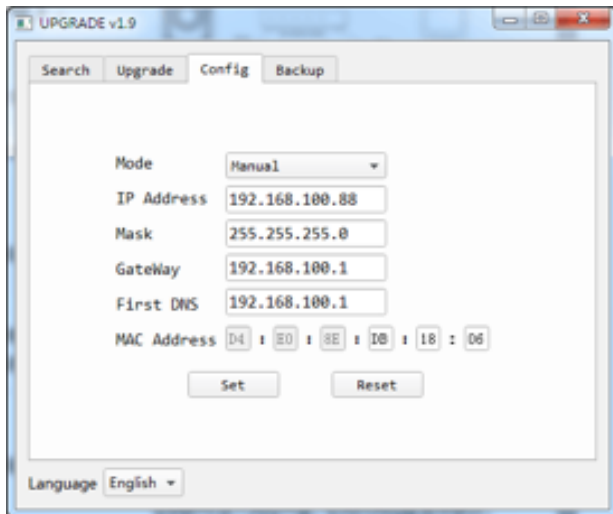

NOTE!

The fault IP address for the camera is "192.168.100.88", and login details are:
user "admin"
password "admin".

4.2 Access IP Camera

Input <http://192.168.100.88> to a browser (eg Internet Explorer, Firefox etc), a login window will pop up, input login name: admin, password: admin, shown as below:



NOTE !

If this is the first time this camera has been accessed via a network, you will need to install media player software such as VLC. Please go to the Videolan web-site (<http://www.videolan.org/vlc>) and download and install VLC (player software).

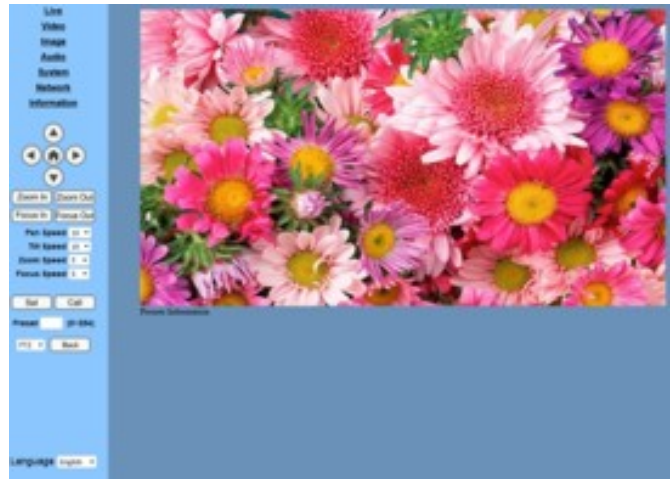

After installation, login again (4.2) and you will see the setup page above.

5. IP Camera accessed/controlled by WAN (Internet)

5.1 Setup IPC accessed/controlled by dynamic DNS

2 dynamic DNS available:

Dyndns.org,
3322.org

Router Port Mapping:

Take Tenda router for example, enter Router Home Page (interface page), select "Advanced" - "Virtual Server", add a new port number in "Ext Port", add a new port number in "Int port", put the camera IP address in "Internal IP", then select "Save", shown as below:

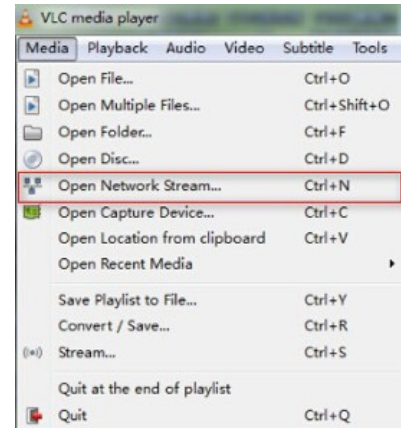
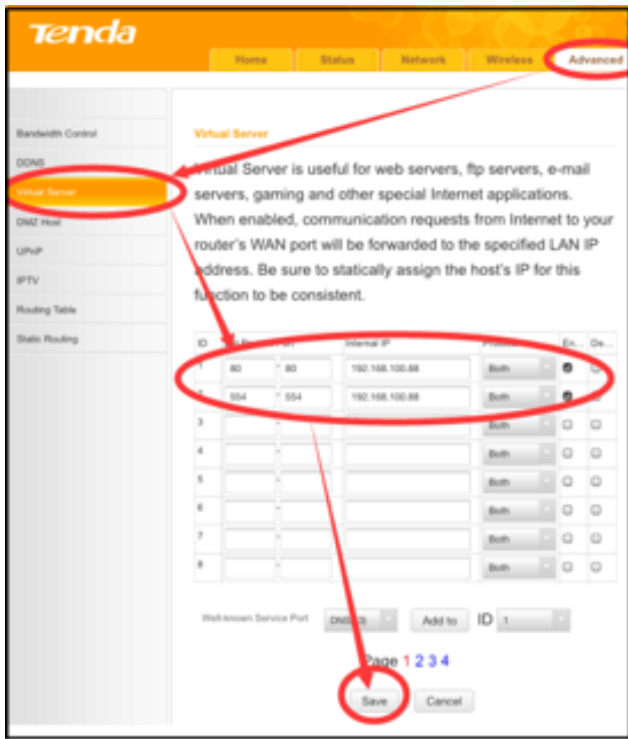

Insert the URL address:
 rtsp://ip: port number/1 (First stream);
 rtsp://ip: port number/2 (Second stream).

NOTE !
 RTSP port number default 554.

5.2 Setting Dynamic DNS

Set the domain name for the camera, setup the parameter, so dynamic DNS can access the camera. Access the link: <http://hostname :port number> (for example, set host computer name: youdomain.f3322.org, camera port number: 554—for this the access url should be: <http://youdomain.3322.org:554>).

NOTE !
 If the camera's port default is 80, then it is not necessary to input the port number, the host name can access the camera directly .

5.3 VLC stream media player monitoring

Using VLC media to view a stream:

Open VLC media player, click "Media", then "Open Network Steam" (or click "Ctrl+N") as show below:

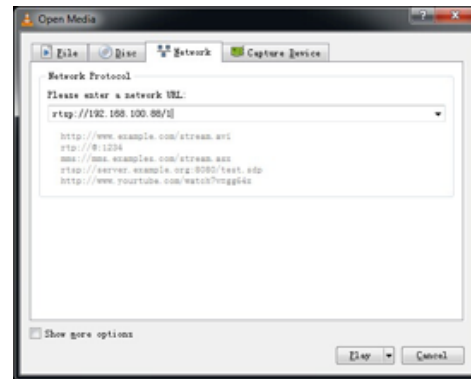

6. IP Camera parameter setup

6.1 Homepage introduction

Menu's

All of the pages contain 2 menu bars, navigation and camera control on the left hand side and the settings page details on the right.



Live

Click the "Live" tab and it will provide a real time video image to help with camera positioning and parameter setup

A. Video viewing window

Video viewing window must be same as video resolution, the bigger the resolution is, the bigger the playing area is. Double click viewing window, will show full-screen, double click again, will return to the initialized size.

The Status Bar in the viewing window shown as below.



- 1) Video playback pause button: control real-time video pause, stop the last picture, click to restart the video again.
- 2) Audio control buttons: can set mute mode.
- 3) Full screen switch button.

B. PTZ Setup

- 1) PTZ direction control box: Up, down, left, right, home button as shown right.
- 2) Rate: Vertical speed can be chosen as 1 ~ 24, horizontal direction at the rate of 1 ~ 20.

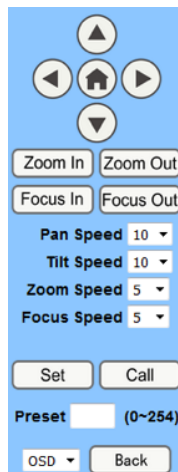

- 3) Select corresponding speed and click direction button to change PTZ speed up or speed down.
- 4) Zoom In/Zoom out: for zooming in or zooming out, Focus In/ Focus Out: Focusing on distant objects or Focusing on close objects.
- 5) Set/Call: When you want to set a specific position and zoom for the camera, you can set up a preset for that position—see below:

Method 1: Type a number into the Preset box.



Method 2: Type name into the Preset information.

Then click the "Set" button.

When you want the camera to return to that preset position, click the relevant "Call" button or click the relevant preset number ("No."). The camera will then turn back to that preset position.

Presets Information		
No.	Name	
1		Set
2		Set
3		Set
4		Set
5		Set
6		Set
7		Set
8		Set
9		Set

6) PTZ Menu: If you select OSD from the dropdown, this setting allows the user to see the On Screen Display (OSD) menu in the video viewing window. Use the PTZ direction control buttons (up/down arrows to select the menu, left/right arrows to modify the submenu and the home button as enter). After the menu has been modified, select PTZ from the dropdown if you are in the main menu, it will save the setting and exit automatically. Otherwise, return to the previous menu by clicking the Back button (effective only in the submenu).



PTZ : system in PTZ mode.

C. Language selection

Chinese/English/Russian

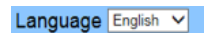

6.2 Video

To set up the video parameters, click the "Video" tab.

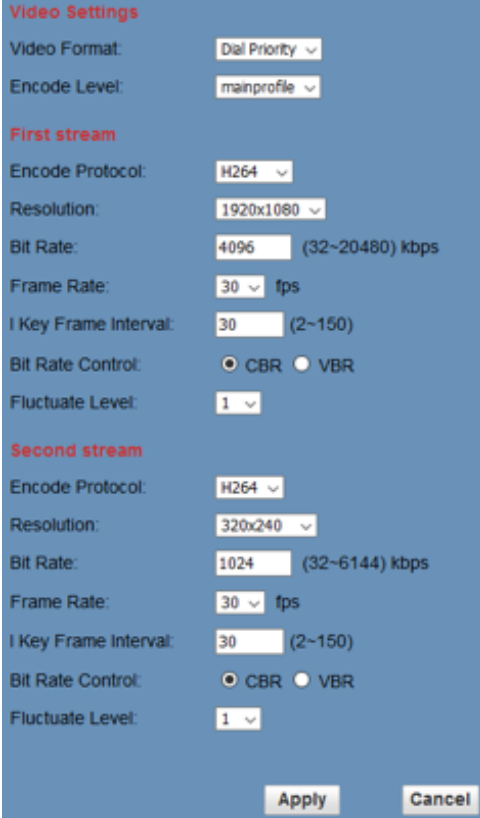

1) Video format

There are 3 formats, support for 50HZ (PAL), 60HZ (NTSC) and Dial priority (chosen via the RC menu).

2) Encode Level

Choose between baseline, mainprofile, highprofile.

3) Encode Protocol

Choose H.264 , H.265 and MJPEG three formats.

4) Resolution

The First stream supports either 1920x1080, 1280x720, 1024x576, 960x540, 640x480, 640x360. The Second stream supports 1280x720, 1024x576, 720x576, 720x408, 640x360, 480x270, 320x240, 320x180.

Note: the bigger the resolution is, the clearer the image will be, but more network bandwidth will be taken.

5) Bit Rate

The user can assign the bit rate flow for each stream. Note: the bigger bit rate is, the clearer the image will be. But the bit rate allocation must combine with the available network bandwidth, when the network bandwidth is too narrow and the allocated bit flow is too big, it will cause the video signal to be compromised and not transmitted normally, ie you are likely to get unsatisfactory video images.

6) Frame Rate

The user can specify the size of the frame rate, generally if the Frame Rate is higher, the image quality is more smooth; If the Frame Rate is smaller, the video image will be more juddery.

7) I Key Frame Interval:

Set the interval between two I frames, the bigger interval is, the response will be lower from viewing window.

8) Bit Rate Control

Choose between:

Constant bit rate: video coder will be coding according to preset speed

Variable bit rate: video coder will adjust the speed based on video bandwidth speed to gain the best image quality.

9) Fluctuate Level

Choose the fluctuation magnitude of variable rate, grade 1 ~ 6

6.3 Image

To adjust the video image, click on "Image" and you will get the following settings:





1) Brightness

Image brightness 0~14, slider control, on the right shows the corresponding numerical. Default 7.

2) Saturation

Saturation 0~14, slider control, on the right shows the corresponding numerical. Default 4.

3) Contrast

Contrast 0~14, slider control, on the right shows the corresponding numerical. Default 7.

4) Sharpness

Sharpness 0~15, slider control, on the right shows the corresponding numerical. Default 2.

5) Hue

Hue 0~14, slider control, on the right shows the corresponding numerical. Default 7.

6) Flip & Mirror

Click Flip to turn the image upside down (useful if you are ceiling mounting the camera),
Click Mirror to horizontally flip the image.

7) Apply

After setting the different parameters, click the "Apply" button to save or click "Cancel" to cancel the adjustment of the parameters. If you click "Default", it will revert to original camera default settings.

6.4 Audio Setup

1) Audio Type

Audio type AAC.

2) Sample rate

Sample rate 44.1K and 48K.

3) Bit rate

Bit rate 96K, 128K, 256K.

4) Input Type

Line in only.

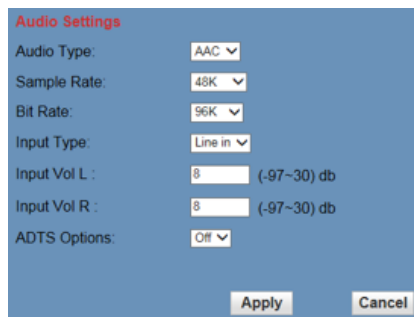

5) Input Vol L

Adjust the volume of the left channel.

6) Input Vol R

Adjust the volume of the right channel.

7) ADTS Options

Optional items: On, Off

8) Button

Press "apply" button to save the setting parameters, press "cancel" button to cancel parameters.

6.5 System Setting

Click the "System" tab to enter the System setting page.

1) Work Mode

The Work Mode is usually RTSP.

2) Reboot

Click the "Reboot" button for a camera system restart.

3) User and password

The user can modify the password (letters and numbers only).

4) Apply / Cancel

If you have modified the password, enter the new password and click the "Apply" button to the login page, or press "cancel" button to cancel password change.



6.6 Network Setting

Click "Network" to enter the network settings page.

1) Lan Settings

The Default IP address is 192.168.100.88.

The MAC address can be modified.



2) Port Settings

A. HTTP Port

IP address identifies the network device, the device can run multiple web applications, each network program using network port to transmit data, so data transmission to be carried out between the port and port. Port setting is to

set up WEB SERVER program using which port to transmit.

When port mapping, need to be consistent with the port number (default port: 80)

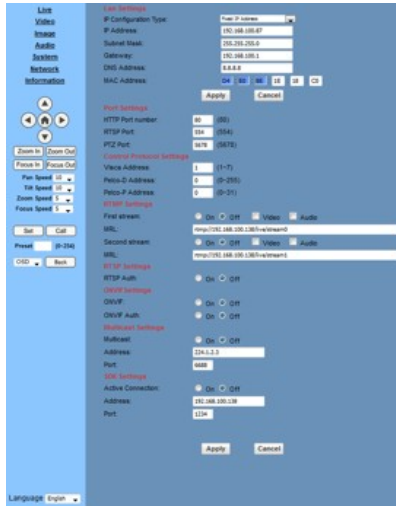

B. RTSP Port

Network camera support RTSP protocol, use the VLC tools broadcast.

C. PTZ Port

Support PTZ protocol, default port: 5678.

3) Control Protocol Setting

Setting camera control communication protocol, include Visca address, Pelco-D address, Pelco-P address.

4) RTMP Setting

Setting the camera stream, can set up two stream, in the two stream selection control code stream of "On", "Off", "Video", "Audio", etc.

5) RTSP Setting

Setting network camera rtsp protocol of "On", "Off".

6) ONVIF Setting

Setting the ONVIF protocol and ONVIF authorization "On", "Off".

7) Multicast Setting

Setting multicast "On", "Off" and multicast address (default address 224.1.2.3) and port (default 6688).

8) Apply / Cancel

Modify network parameters then press "Apply" button to modify network parameters, press "Cancel" button to cancel network parameters.

6.7 Information

Click "Information" to show the current device information, as shown below.



7. Download the Network upgrade program

If you need the camera upgrade program, please contact networktv.tv.

Maintenance & Troubleshooting

Camera Maintenance

- If camera will not be used for a long time, please turn off the power switch, disconnect AC power cord of AC adaptor to the outlet.
- Use soft cloth or tissue to clean the camera cover.
- Please use the soft dry cloth to clean the lens. If the camera is very dirty, clean it with diluted neutral detergent. Do not use any type of solvents, which may damages the surface.

Unqualified Application

- No shooting extreme bright object for a long period of time, such as sunlight, light sources, etc.
- No operating in unstable lighting conditions, otherwise image will be flickering.
- No operating close to powerful electromagnetic radiation, such as TV or radio transmitters, etc.

Troubleshooting

Image

- No image
 1. Check whether the power cord is connected, voltage is OK, POWER lamp is light.
 2. Check whether the camera can self-test after startup.
 3. Check video cable is connected correctly.
- Abnormal display of image
 - Check video cable is connected correctly.
- Image dithering even at widest zoom position
 1. Check whether camera is fixed correctly.
 2. Make sure if there are something like vibration machine or other things nearby.

Control

- IR remote controller cannot control the camera
 1. Change the battery
 2. Check the camera working mode.
 3. Check IR address of the Remote Commander is set correctly.

Serial communication cannot control the camera

1. Check the camera working mode.
2. Check control cable is connected correctly.



No video image IE browser

When the IP camera is used for the first time and accessed by Internet Explorer (or other web browser), you first need to install a media player plug-in. If you are using the camera via the Internet (for new users), then you will need to install a player software (VLC). Please go to the VLC website <http://www.videolan.org/vlc>, download and install VLC (player software). After installation, login again, and the video image is displayed (see the Network Function section, point 5.3).

Follow the checklist below if you are unable to access IP camera web pages via a browser:

1. Access the network with a PC and test whether you can access the camera via a Ping test. You may have a firewall issue or a cable may be unplugged.
2. If you need to, disconnect IP camera from the network and connect it to a PC (please refer to the Network Function section) to re-set the IP address.
3. Check the camera's IP address, subnet mask and gateway address.
4. Check for MAC addresses conflict.
5. Check that the Web port is not occupied by other devices.

If you modify the IP address and set it incorrectly, or forget web passwords, press the IR remote controller "[*]+[#]+[Manual]" to restore the default value (Default IP: 192.168.100.88 Default username: admin Default password: admin)